

# JVC

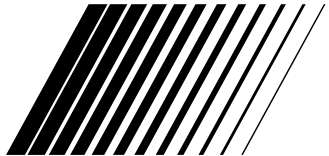

**CASSETTE RECEIVER**

**KS-FX200**

**RECEPTOR-REPRODUCTOR DE  
CASSETTE**

**KS-FX200**

**RADIOCASSETTE**

**KS-FX200**

ENGLISH

ESPAÑOL

FRANÇAIS

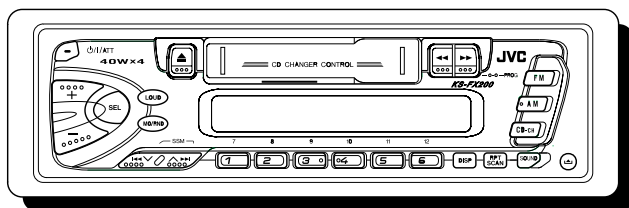
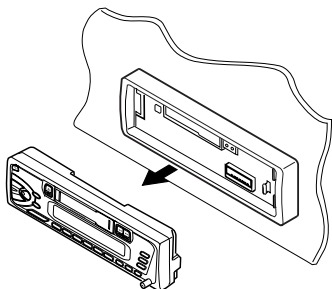

For installation and connections, refer to the separate manual.  
Para la instalación y las conexiones, refiérase al manual separado.  
Pour l'installation et les raccordements, se référer au manuel séparé.

## INSTRUCTIONS

MANUAL DE INSTRUCCIONES  
MANUEL D'INSTRUCTIONS

**For customer Use:**

Enter below the Model No. and Serial No. which are located on the top or bottom of the cabinet. Retain this information for future reference.

Model No. \_\_\_\_\_

Serial No. \_\_\_\_\_

GET0001-001A

[J]

Thank you for purchasing a JVC product. Please read all instructions carefully before operation, to ensure your complete understanding and to obtain the best possible performance from the unit.

# CONTENTS

**BASIC OPERATIONS** ..... 3



**RADIO OPERATIONS** ..... 4

Listening to the radio ..... 4

Storing stations in memory ..... 5

    FM station automatic preset: SSM ..... 5

    Manual preset ..... 6

Tuning into a preset station ..... 7

Other convenient tuner functions ..... 8

    Scanning broadcast stations ..... 8

    Selecting FM reception sound ..... 8

    Changing the AM/FM channel intervals ..... 8



**TAPE OPERATIONS** ..... 9

Listening to a tape ..... 9



**SOUND ADJUSTMENTS** ..... 10

Turning on/off the loudness function ..... 10

Selecting preset sound modes ..... 10

Adjusting the sound ..... 11

Storing your own sound adjustments ..... 12



**OTHER MAIN FUNCTIONS** ..... 13

Setting the clock ..... 13

Detaching the control panel ..... 14



**CD CHANGER OPERATIONS** ..... 15

Playing CDs ..... 15

Selecting CD playback modes ..... 17



**MAINTENANCE** ..... 18

To extend the lifetime of the unit ..... 18

How to reset your unit ..... 18



**TROUBLESHOOTING** ..... 19

**SPECIFICATIONS** ..... 20

## BEFORE USE

**\* For safety...**

- Do not raise the volume level too much, as this will block outside sounds, making driving dangerous.
- Stop the car before performing any complicated operations.

**\* Temperature inside the car...**

If you have parked the car for a long time in hot or cold weather, wait until the temperature in the car becomes normal before operating the unit.

# BASIC OPERATIONS

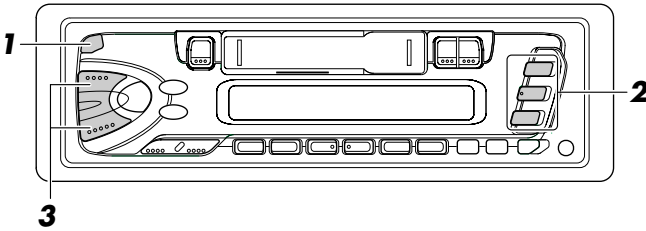

**Note:**

When you use this unit for the first time, set the built-in clock correctly, see page 13.

1

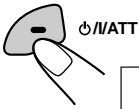

Turn on the power.

**Notes on One-Touch Operation:**

- When you select tuner as a source in step 2 below, the power automatically comes on. You do not have to press this button to turn on the power.
- If the cassette is already in the cassette compartment, tape play starts automatically. However, it is not recommended to leave the cassette in the compartment when turning off the power or ignition key. It may damage the tape head and the cassette.

2

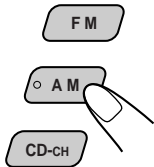

Play the source.

To operate the tuner, see pages 4 – 8.

To operate the tape deck, see page 9.

To operate the CD changer, see pages 15 – 17.

3

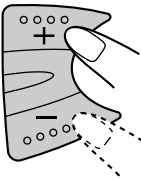

Adjust the volume.

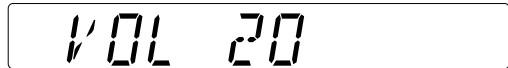

Volume level appears

4

Adjust the sound as you want (see pages 10 – 12).

**To drop the volume in a moment**

Press  $\odot$ /ATT briefly while listening to any source. “ATT” starts flashing on the display, and the volume level will drop in a moment.

To resume the previous volume level, press the button briefly again.

**To turn off the power**

Press  $\odot$ /ATT for more than 1 second.



# RADIO OPERATIONS

ENGLISH

## Listening to the radio

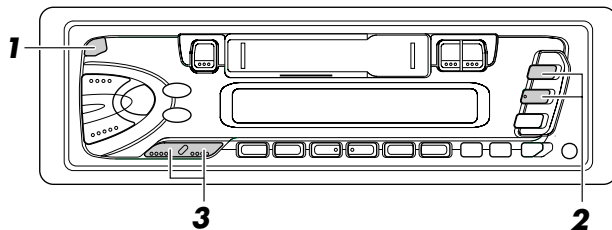

1



Turn on the power.

### Note on One-Touch Operation:

When you select a band in step 2 below, the power automatically comes on. You do not have to press this button to turn on the power.

2

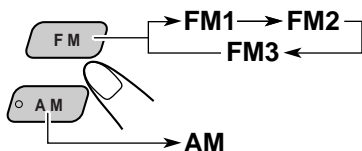

Select the band (FM1, FM2, FM3 or AM).

You can select any one of FM1, FM2, and FM3 to listen to an FM station.



### Note:

When a cassette is in the cassette compartment, you cannot select the tuner. Be sure to eject the cassette from the cassette compartment to listen to the radio.

3

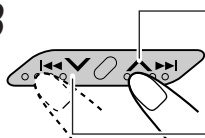

To search stations of higher frequencies.

To search stations of lower frequencies.

Start searching a station.

When a station is received, searching stops.



To stop searching before a station is received, press the same button you have pressed for searching.

### To tune in a particular frequency manually:

1 Press FM or AM to select the band.

2 Press and hold  $\blacktriangle$   $\blacktriangleright$   $\blacktriangleleft$   $\blacktriangledown$  until "M" starts flashing on the display.

Now you can manually change the frequency while "M" is flashing.

3 Press  $\blacktriangle$   $\blacktriangleright$   $\blacktriangleleft$   $\blacktriangledown$  repeatedly until the frequency you want is reached.

- If you hold down the button, the frequency keeps changing until you release the button.

## Storing stations in memory

You can use one of the following two methods to store broadcasting stations in memory.

- Automatic preset of FM stations: SSM (Strong-station Sequential Memory)
- Manual preset of both FM and AM stations.

### FM station automatic preset: SSM

You can preset 6 local FM stations in each FM band (FM1, FM2 and FM3).

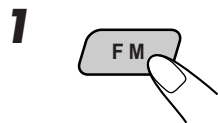
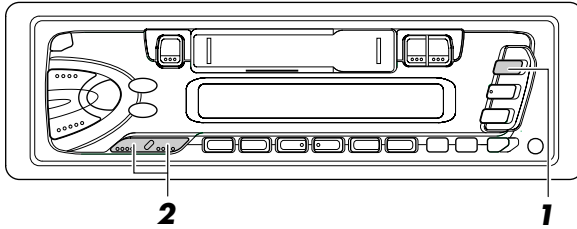

Select the FM band number (FM1, FM2 or FM3) you want to store FM stations into.

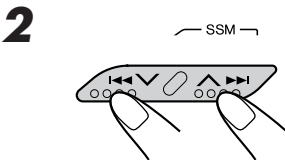

Press and hold the button for more than 2 seconds.

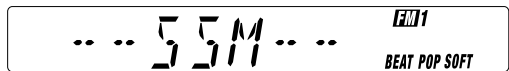

"SSM" appears, then disappears when automatic preset is over.

Local FM stations with the strongest signals are searched and stored automatically in the band number you have selected (FM1, FM2 or FM3). These stations are preset in the number buttons — No. 1 (lowest frequency) to No. 6 (highest frequency).

When automatic preset is over, the station stored in number button 1 will be automatically tuned in.



## Manual preset

You can preset up to 6 stations in each band (FM1, FM2, FM3 and AM) manually.

Example: Storing an FM station of 88.3 MHz into the preset number 1 of the FM1 band.

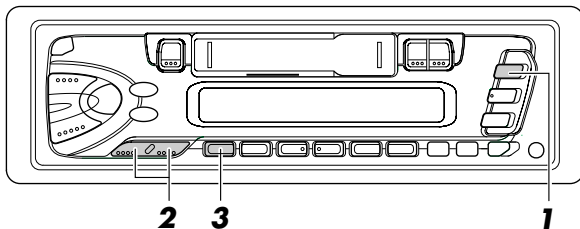

1

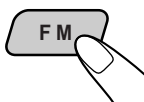

Select the FM1 band.

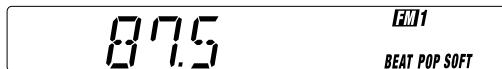

2

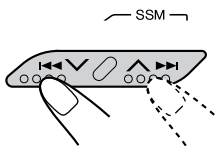

Tune into a station of 88.3 MHz.

See page 4 to tune into a station.



3



Press and hold the button for more than 2 seconds.



Preset number "P1" flashes for a while.

4

Repeat the above procedure to store other stations into other preset numbers.

### Notes:

- A previously preset station is erased when a new station is stored in the same preset number.
- Preset stations are erased when the power supply to the memory circuit is interrupted (for example, during battery replacement). If this occurs, preset the stations again.

# Tuning into a preset station

You can easily tune into a preset station.  
Remember that you must store stations first. If you have not stored them yet, see page 5 or 6.

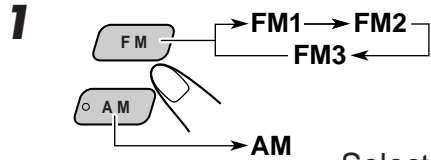
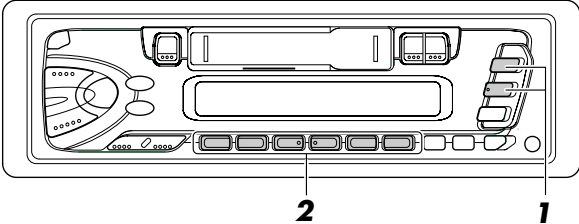

Select the band (FM1, FM2, FM3 or AM) you want.

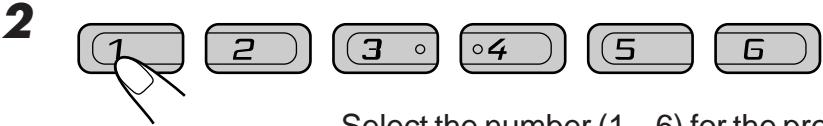

Select the number (1 – 6) for the preset station you want.



## Other convenient tuner functions

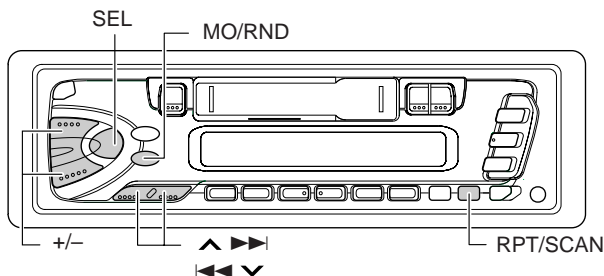

### Scanning broadcast stations

When you press RPT/SCAN while listening to the radio, station scanning starts. Each time a broadcast is tuned in, scanning stops for about 5 seconds (tuned frequency number flashes on the display), and you can check what program is now being broadcast.

If you want to listen to that program, press the same button again to stop scanning.

### Selecting FM reception sound

**When an FM stereo broadcast is hard to receive:**

Press MO/RND while listening to an FM stereo broadcast. The sound you hear becomes monaural but reception will be improved.

Lights when receiving an FM broadcast in stereo



To restore the stereo effect, press the same button again.

### Changing the AM/FM channel intervals

**When using this unit in an area other than North or South America:**

When this unit is shipped from the factory, the channel intervals are set to 10 kHz for AM and 200 kHz for FM. You can change the channel intervals by following the procedure below.

- 1 Press SEL (select) for more than 2 seconds.  
"CLOCK H," "CLOCK M" or "AREA" appears on the display.
- 2 If "AREA" does not appear, press  $\blacktriangle$   $\blacktriangleright$  or  $\blacktriangleleft$   $\blacktriangledown$  until it appears.
- 3 Press +.  
"AREA EU" appears and the channel intervals are set to 9 kHz for AM and 50 kHz (for manual tuning) / 100 kHz (for searching) for FM.

**To reset to the factory setting**, follow the above step 1 and 2, then press – in step 3 ("AREA US" appears on the display.)

AREA EU: Select this when used in an area other than North and South America.  
AREA US: Select this when used in North or South America.



# TAPE OPERATIONS



## Listening to a tape

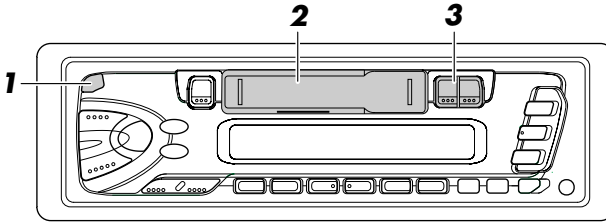

1



Turn on the power.

2

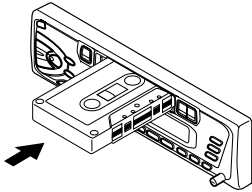

Insert a cassette.

When one side of the tape reaches its end during play, the other side of the tape automatically starts playing. (Auto Reverse)

3

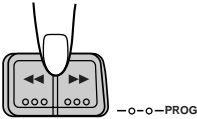

Select the tape direction.

- Press the both buttons at the same time.

Each time you press the button, the tape direction changes alternatively – forward (TAPE >>>) and reverse (TAPE <<<).

### To stop play and eject the cassette

Press ▲.

Tape play stops and the cassette ejects from the cassette compartment.

You can hear the last received station.

- You can also eject the cassette with the unit turned off.

### To fast-wind a tape

Press either ►► or ◀◀.

The tape will be wound in the direction of the arrows (►► or ◀◀).

To restart playback, press ►► or ◀◀ lightly.

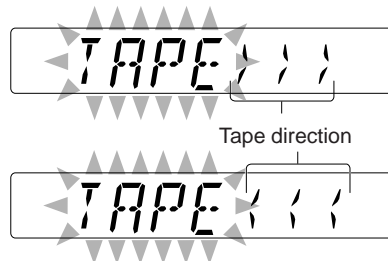



# SOUND ADJUSTMENTS

## Turning on/off the loudness function

The human ear is less sensitive to low and high frequencies at low volumes. The loudness function can boost these frequencies to produce a well-balanced sound at low volume levels.

Each time you press LOUD, the loudness function turns on/off alternatively.

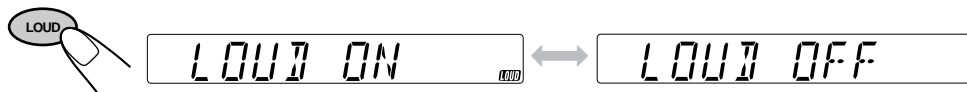

## Selecting preset sound modes

You can select a preset sound adjustment suitable to the music genre.

Each time you press SOUND, the sound mode changes as follows.



Indication	For:	Preset values		
		Bass	Treble	Loudness
SCM OFF	(Flat sound)	00	00	On
BEAT	Rock or disco music	+2	00	On
POP	Light music	+4	+1	Off
SOFT	Quiet background music	+1	-3	Off

### Notes:

- You can adjust the preset sound mode to your preference, and store it in memory. If you want to adjust and store your original sound mode, see “Storing your own sound adjustments” on page 12.
- To adjust only the bass and treble reinforcement levels to your preference, see “Adjusting the sound” on page 11.
- When one of the sound modes is selected, it is shown on the display as follows:

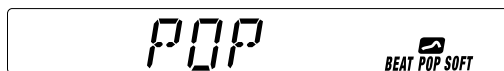

For example, when “POP” is selected.

## Adjusting the sound

You can adjust the treble/bass sound and the speaker balance.

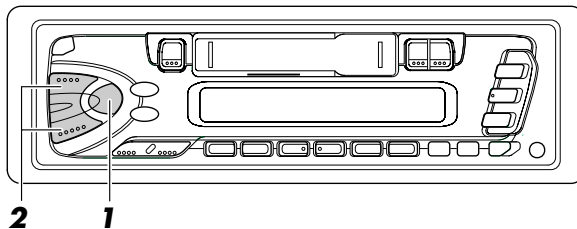
**1**



Select the item you want to adjust.

→ **BAS** → **TRE** → **FAD** → **BAL** → **VOL** →

Indication	To do:	Range
BAS (bass)	Adjust the bass	-6 (min.) — +6 (max.)
TRE (treble)	Adjust the treble	-6 (min.) — +6 (max.)
FAD (Fader)*	Adjust the front and rear speaker balance	R6 (rear only) — F6 (front only)
BAL (Balance)	Adjust the left and right speaker balance	L6 (left only) — R6 (right only)
VOL (Volume)	Adjust the volume	00 (min.) — 50 (max.)

**Note:**

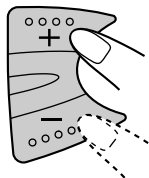
\* If you are using a two-speaker system, set the fader level to "00".

**2**

Adjust the level.

**Note:**

Normally the + and - buttons work as the volume control buttons. So you do not have to select "VOL" to adjust the volume level.



## Storing your own sound adjustments

You can adjust the sound modes (BEAT, POP, SOFT: see page 10) to your preference and store your own adjustments in memory.

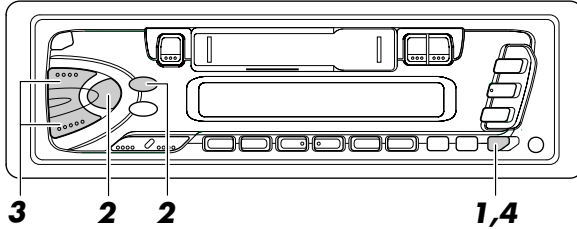

**1**

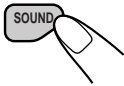

Call up the sound mode you want to adjust.  
See page 10 for details.

**Within  
5 seconds**

**2**

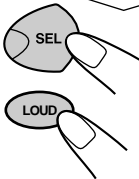

To adjust the bass or treble sound level  
Select "BAS" or "TRE."

To turn on or off the loudness function

Each time you press LOUD, the loudness function turns on and off alternatively. (→ go to step 4)

**Within  
5 seconds**

**3**

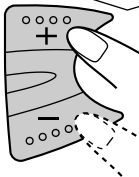

Adjust the bass or treble level.  
See page 11 for details.

**Within  
5 seconds**

**4**

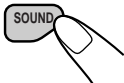

Press and hold SOUND until the sound mode you have selected in step **1** flashes on the display.

Your setting is stored in memory.

**5**

Repeat the same procedure to store other settings.

### To reset to the factory settings

Repeat the same procedure and reassign the preset values listed in the table on page 10.

# OTHER MAIN FUNCTIONS



ENGLISH

## Setting the clock

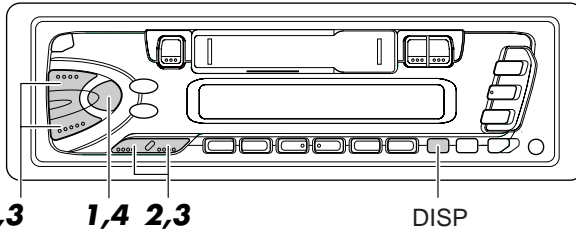

**1**  Press and hold the button for more than 2 seconds.  
"CLOCK H," "CLOCK M" or "AREA" appears on the display.

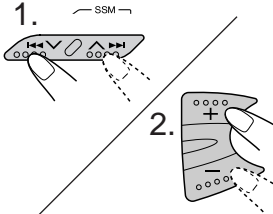
**2**  Set the hour.  
1. Select "CLOCK H" if not shown on the display.  
→ CLOCK H → CLOCK M → AREA  
2. Adjust the hour.

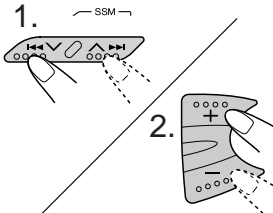
**3**  Set the minute.  
1. Select "CLOCK M."  
→ CLOCK H → CLOCK M → AREA  
2. Adjust the minute.

**4**  Start the clock.

### To check the current clock time (changing the display mode)

Press DISP repeatedly. Each time you press the button, the display mode changes as follows.

<p>During tuner operation: Frequency ↔ Clock</p>	<p>During tape operation: Play mode ↔ Clock</p>	<p>During CD changer operation: Elapsed playing time → Disc number ↑ Clock</p>
--	---	--

## Detaching the control panel

You can detach the control panel when leaving the car.  
When detaching or attaching the control panel, be careful not to damage the connectors on the back of the control panel and on the panel holder.

### How to detach the control panel

Before detaching the control panel, be sure to turn off the power.

- 1 Unlock the control panel.

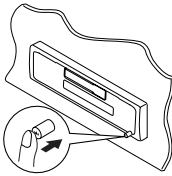

- 2 Lift and pull the control panel out of the unit.

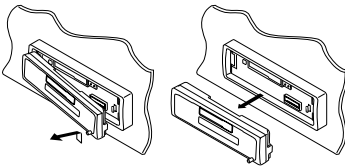

- 3 Put the detached control panel into the provided case.

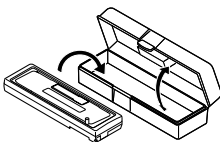

### How to attach the control panel

- 1 Insert the left side of the control panel into the groove on the panel holder.

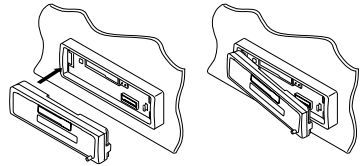

- 2 Press the right side of the control panel to fix it to the panel holder.

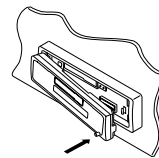

#### Note on cleaning the connectors:

*If you frequently detach the control panel, the connectors will deteriorate.*

*To minimize this possibility, periodically wipe the connectors with a cotton swab or cloth moistened with alcohol, being careful not to damage the connectors.*

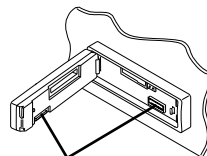

Connectors

# CD CHANGER OPERATIONS

We recommend that you use one of the CH-X series with your unit.

If you have another CD automatic changer, consult your JVC car audio dealer for connections.

- For example, if your CD automatic changer is one of the KD-MK series, you need a cord (KS-U15K) for connecting it to this unit.

Before operating your CD automatic changer:

- Refer also to the Instructions supplied with your CD changer.
- If no discs are in the magazine of the CD changer or the discs are inserted upside down, "NO CD" or "NO DISC" will appear on the display. If this happens, remove the magazine and set the discs correctly.
- If "RESET 1 - RESET 8" appears on the display, something is wrong with the connection between this unit and the CD changer. If this happens, check the connection, connect the connecting cord(s) firmly if necessary, then press the reset button of the CD changer.

## Playing CDs

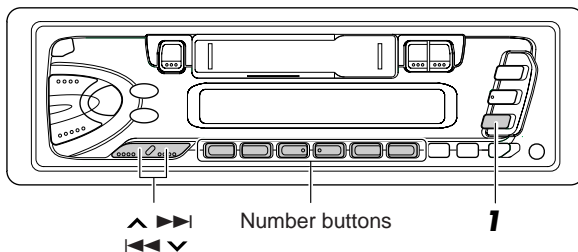

1

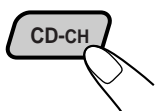

Select the CD automatic changer.

Playback starts from the first track of the first disc.  
All tracks of all discs are played back.

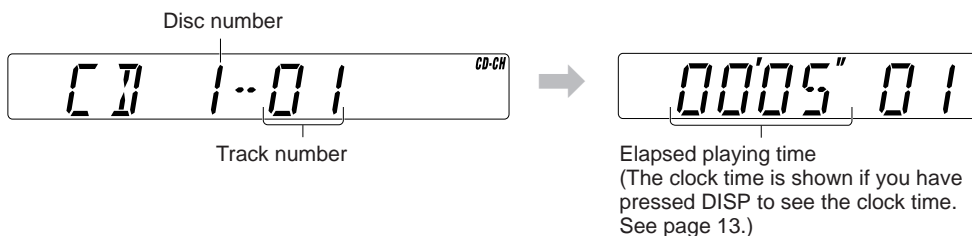

### Note on One-Touch Operation:

When you press CD-CH, the power automatically comes on. You do not have to press /I/ATT to turn on the power.



## To fast forward or reverse the track

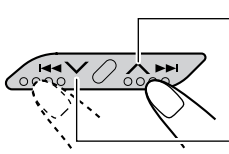

Press and hold **⏭**, while playing a CD, to fast forward the track.

Press and hold **⏮**, while playing a CD, to reverse the track.

## To go to the next track or the previous track

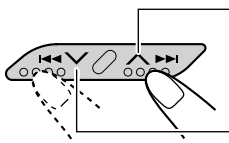

Press **⏭** briefly, while playing a CD, to go ahead to the beginning of the next track. Each time you press the button consecutively, the beginning of the next tracks is located and played back.

Press **⏮** briefly, while playing a CD, to go back to the beginning of the current track. Each time you press the button consecutively, the beginning of the previous tracks is located and played back.

## To go to a particular disc directly

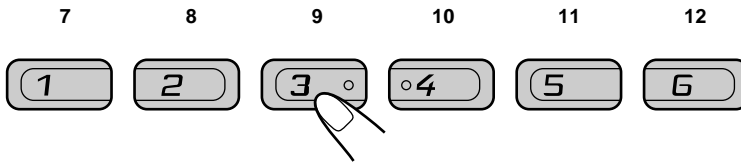

Press the number button corresponding to the disc number to start its playback.

- To select a disc number from 1 – 6:  
Press 1 (7) – 6 (12) briefly.
- To select a disc number from 7 – 12:  
Press and hold 1 (7) – 6 (12) for more than 1 second.

Ex. When disc number 3 is selected

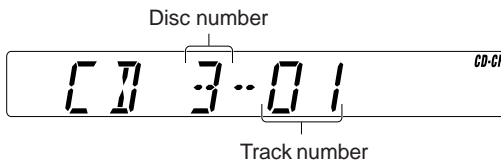



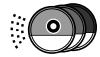

# Selecting CD playback modes

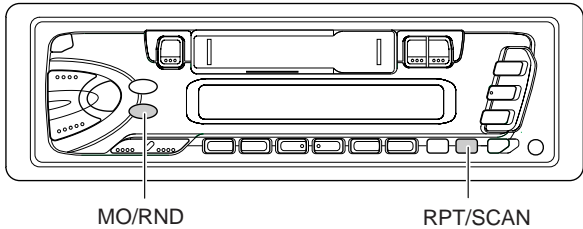

## To play back tracks at random (Random Play)

Each time you press MO/RND (Mono/Random) while playing a CD, CD random play mode changes as follows:

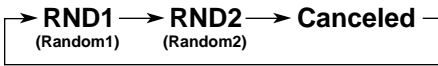

Mode	RND Indicator	Plays at random
RND1	Lights	All tracks of the current disc, then the tracks of the next disc, and so on.
RND2	Flashes	All tracks of all discs inserted in the magazine.

## To play back tracks repeatedly (Repeat Play)

Each time you press RPT/SCAN (Repeat/Scan) while playing a CD, CD repeat play mode changes as follows:



Mode	RPT Indicator	Plays repeatedly
RPT1	Lights	The current track (or specified track).
RPT2	Flashes	All tracks of the current disc (or specified disc).



# MAINTENANCE

ENGLISH

## To extend the lifetime of the unit

This unit requires very little attention, but you will be able to extend the life of the unit if you follow the instructions below.

### To clean the heads

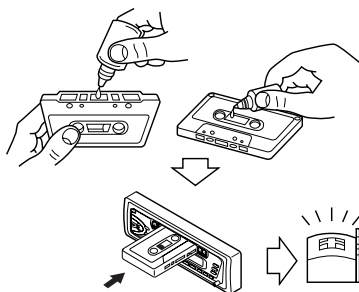

- Clean the heads after every 10 hours of use using a wet-type head cleaning tape (available at an audio store).  
When the head becomes dirty, you may realize the following symptoms:
  - Sound quality is reduced.
  - Sound level decreases.
  - Sound drops out.
- Do not play dirty or dusty tapes.
- Do not touch the highly-polished head with any metallic or magnetic tools.

### To keep the tape clean

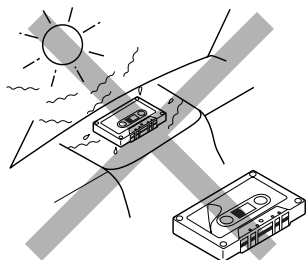

- Always store the tapes to their storage cases after use.
- Do not store tapes in the following places:
  - Subject to direct sunlight
  - With high humidity
  - At extremely hot temperatures

### CAUTIONS:

- Do not play the tapes with peeling labels; otherwise, they can damage the unit.
- Tighten tapes to remove slack since loose tape may become entangled with the mechanism.
- Do not leave a cassette in the cassette compartment after use, as the tape may become slack.

## How to reset your unit

Press and hold both the SEL (Select) and  $\text{O/I/ATT}$  (Standby/On/ATT) buttons at the same time for several seconds.

This will reset the built-in microcomputer.

**NOTE:** Your preset adjustments — such as preset channels or sound adjustments — will also be erased.

$\text{O/I/ATT}$   
(Standby/On/ATT)

SEL (Select)

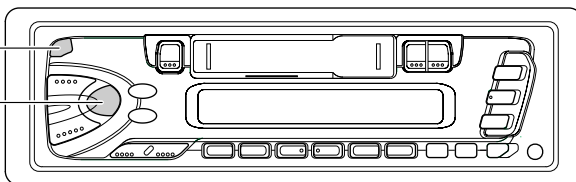

# TROUBLESHOOTING

What appears to be trouble is not always serious. Check the following points before calling a service center.

Symptoms	Causes	Remedies
<ul style="list-style-type: none"> <li>A cassette tape cannot be inserted.</li> </ul>	You have tried to insert a cassette in the wrong way.	Insert the cassette with the exposed tape facing right.
<ul style="list-style-type: none"> <li>Cassette tapes become hot.</li> </ul>	This is not a malfunction.	_____
<ul style="list-style-type: none"> <li>Tape sound is at very low level and sound quality is degraded.</li> </ul>	The tape head is dirty.	Clean it with a head cleaning tape.
<ul style="list-style-type: none"> <li>Sound is sometimes interrupted.</li> </ul>	Connections are not good.	Check the cords and connections.
<ul style="list-style-type: none"> <li>Sound cannot be heard from the speakers.</li> </ul>	The volume control is turned to the minimum level.	Adjust it to the optimum level.
	Connections are incorrect.	Check the cords and connections.
<ul style="list-style-type: none"> <li>Static noise while listening to the radio.</li> </ul>	The antenna is not connected firmly.	Connect the antenna firmly.
<ul style="list-style-type: none"> <li>“NO CD” or “NO DISC” appears on the display.</li> </ul>	No CD is in the magazine.	Insert CDs into the magazine.
	CDs are inserted incorrectly.	Insert them correctly.
<ul style="list-style-type: none"> <li>“RESET 8” appears on the display.</li> </ul>	This unit is not connected to a CD changer correctly.	Connect this unit and the CD changer correctly and press the reset button of the CD changer.
<ul style="list-style-type: none"> <li>“RESET 1-RESET 7” appears on the display.</li> </ul>	_____	Press the reset button of the CD changer.
<ul style="list-style-type: none"> <li>The unit does not work at all.</li> <li>The CD changer does not work at all.</li> </ul>	The built-in microcomputer may function incorrectly due to noise, etc.	While holding SEL, press  /ATT for more than 2 seconds to reset the unit. (The clock setting and preset stations stored in memory are erased.) (See page 18).

# SPECIFICATIONS

ENGLISH

## AUDIO AMPLIFIER SECTION

Maximum Power Output:

Front: 40 watts per channel

Rear: 40 watts per channel

Continuous Power Output (RMS):

Front: 16 watts per channel into 4  $\Omega$ , 40 to 20 000 Hz at no more than 0.8% total harmonic distortion.

Rear: 16 watts per channel into 4  $\Omega$ , 40 to 20 000 Hz at no more than 0.8% total harmonic distortion.

Load Impedance: 4  $\Omega$  (4 to 8  $\Omega$  allowance)

Tone Control Range

Bass:  $\pm 10$  dB at 100 Hz

Treble:  $\pm 10$  dB at 10 kHz

Frequency Response: 40 to 20 000 Hz

Signal-to-Noise Ratio: 70 dB

Line-Out Level/Impedance: 1.0 V/20 k $\Omega$  load (full scale)

Output Impedance: 1 k $\Omega$

## TUNER SECTION

Frequency Range

FM: 87.5 to 107.9 MHz

(with channel interval set to 200 kHz)

87.5 to 108.0 MHz

(with channel interval set to 50 kHz)

AM: 530 to 1 710 kHz

(with channel interval set to 10 kHz)

531 to 1 602 kHz

(with channel interval set to 9 kHz)

### [FM Tuner]

Usable Sensitivity: 11.3 dBf (1.0  $\mu$ V/75  $\Omega$ )

50 dB Quieting Sensitivity:

16.3 dBf (1.8  $\mu$ V/75  $\Omega$ )

Alternate Channel Selectivity (400 kHz):

65 dB

Frequency Response: 40 to 15 000 Hz

Stereo Separation: 35 dB

Capture Ratio: 2.0 dB

### [AM Tuner]

Sensitivity: 20  $\mu$ V

Selectivity: 35 dB

## CASSETTE DECK SECTION

Wow & Flutter: 0.15% (WRMS)

Fast-Wind Time: 190 sec. (C-60)

Frequency Response:

50 to 14 000 Hz ( $\pm 3$  dB)

Signal-to-Noise Ratio: 52 dB

Stereo Separation: 40 dB

## GENERAL

Power Requirement

Operating Voltage: DC 14.4 volts (11 to 16 volts allowance)

Grounding System: Negative ground

Allowable Working Temperature:

0°C to +40°C (32°F to 104°F)

Dimensions (W x H x D)

Installation Size:

182 x 52 x 150 mm

(7-3/16" x 2-1/16" x 5-15/16")

Panel Size: 188 x 58 x 14 mm

(7-7/16" x 2-5/16" x 5/8")

Mass: 1.3 kg (2.9 lbs) (excluding accessories)

*Design and specifications subject to change without notice.*

If a kit is necessary for your car, consult your telephone directory for the nearest car audio speciality shop.



**JVC**  
**MOBILE**  
**ENTERTAINMENT**

<http://www.jvcmobile.com>

*Visit us on-line for*

*Technical Support & Customer Satisfaction Survey.*

**US RESIDENTS ONLY**

**Having TROUBLE with operation?  
Please reset your unit**

**Refer to page of How to Reset  
Still having trouble??**

**USA ONLY**

**Call 1-800-252-5722**

<http://www.jvcservice.com>

**We can help you!**

**JVC**

VICTOR COMPANY OF JAPAN, LIMITED

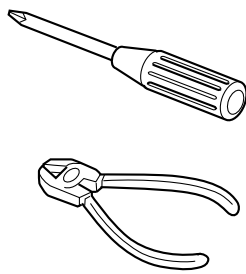

#### ENGLISH

- This unit is designed to operate on 12 volts DC, NEGATIVE ground electrical systems.

### INSTALLATION (IN-DASH MOUNTING)

- The following illustration shows a typical installation. However, you should make adjustments corresponding to your specific car. If you have any questions or require information regarding installation kits, consult your JVC car audio dealer or a company supplying kits.

**1 Before mounting:** Press (Control Panel Release button) to detach the control panel.

**2** Remove the trim plate.

**3** Remove the sleeve after disengaging the sleeve locks.

① Stand the unit.

**Note:** When you stand the unit, be careful not to damage the fuse on the rear.

② Insert the 2 handles between the unit and the sleeve, as illustrated, to disengage the sleeve locks.

③ Remove the sleeve.

**Note:** Be sure to keep the handles for future use after installing the unit.

**4** Install the sleeve in the dashboard.

\* After the sleeve is correctly installed in the dashboard, bend the appropriate tabs to hold the sleeve firmly in place, as illustrated.

**5** Fix the mounting bolt to the rear of the unit's body and place the rubber cushion over the end of the bolt.

**6** Do the required electrical connections explained on the back of this instructions.

**7** Slide the unit into the sleeve until it is locked.

**8** Attach the trim plate.

**9** Attach the control panel.

#### ESPAÑOL

- Esta unidad está diseñada para funcionar con 12 voltios de CC, con sistemas eléctricos de masa NEGATIVA.

### INSTALACION (MONTAJE EN EL TABLERO DE INSTRUMENTOS)

- La siguiente ilustración muestra una instalación típica. Sin embargo usted deberá efectuar los ajustes correspondientes a su automóvil. Si tiene alguna pregunta o necesita información acerca de las herramientas para instalación, consulte con su concesionario de JVC de equipos de audio para automóviles o a una compañía que suministra tales herramientas.

**1 Antes de instalar:** Presione (botón de liberación del panel de control) para desmontar el panel de control.

**2** Retire la placa de guarnición.

**3** Retire la cubierta después de desenganchar los retenes de la cubierta.

① Ponga la unidad vertical.

**Nota:** Al poner la unidad vertical, tenga cuidado de no dañar el fusible provisto en la parte posterior.

② Inserte las dos asas entre la unidad y la cubierta tal como en la ilustración y desenganche los retenes de la cubierta.

③ Retire la cubierta.

**Nota:** Después de instalar la unidad, asegúrese de guardar las asas para uso futuro.

**4** Instale la cubierta en el tablero de instrumentos.

\* Después de que la cubierta esté correctamente instalada en el tablero de instrumentos, doble las lengüetas correspondientes para sostener la cubierta firmemente en su lugar, tal como se muestra.

**5** Fije el perno de montaje o la parte trasera del cuerpo de la unidad y coloque el cojín de goma sobre el extremo del perno.

**6** Realice las conexiones eléctricas requeridas en base a las explicaciones que figuran en la parte de atrás de estas instrucciones.

**7** Deslice la unidad dentro de la cubierta hasta que quede trabada.

**8** Coloque la placa de guarnición.

**9** Coloque el panel de control.

#### FRANÇAIS

- Cet appareil est conçu pour fonctionner sur des sources de courant continu de 12 volts à masse NEGATIVE.

### INSTALLATION (MONTAGE DANS LE TABLEAU DE BORD)

- L'illustration suivante est un exemple d'installation typique. Cependant, vous devez faire les ajustements correspondant à votre voiture particulière. Si vous avez des questions ou avez besoin d'information sur des kits d'installation, consulter votre revendeur d'autoradios JVC ou une compagnie d'approvisionnement.

**1 Avant le montage:** Appuyer sur (touche de libération du panneau de commande) pour détacher le panneau de commande.

**2** Retirer la plaque d'assemblage.

**3** Libérer les verrous du manchon et retirer le manchon.

① Poser l'appareil à la verticale.

**Remarque:** Lorsque vous mettez l'appareil à la verticale, faire attention de ne pas endommager le fusible situé sur le fond.

② Insérer les 2 poignées entre l'appareil et le manchon comme indiqué pour désengager les verrous de manchon.

③ Retirer le manchon.

**Remarque:** S'assurer de garder les poignées pour une utilisation ultérieure, après l'installation de l'appareil.

**4** Installer le manchon dans le tableau de bord.

\* Après installation correcte du manchon dans le tableau de bord, plier les bonnes pattes pour maintenir fermement le manchon en place, comme montré.

**5** Monter le boulon de montage sur l'arrière du corps de l'appareil puis passer l'amortisseur en caoutchouc sur l'extrémité du boulon.

**6** Réaliser les connexions électriques expliquées au dos de cette page.

**7** Faire glisser l'appareil dans le manchon jusqu'à ce qu'il soit verrouillé.

**8** Fixer la plaque d'assemblage.

**9** Remonter le panneau de commande.

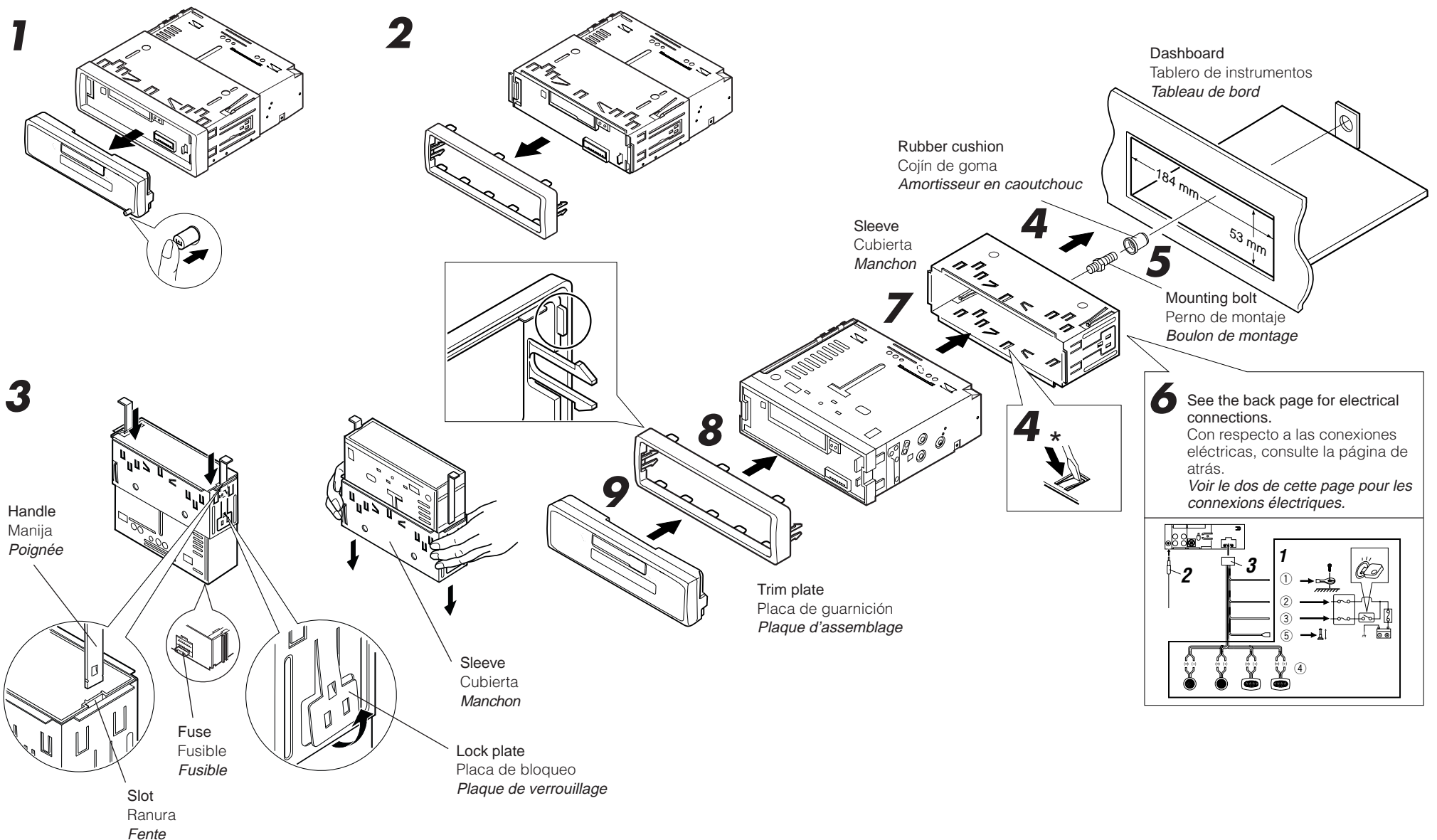

- When using the optional stay
- Cuando emplea un soporte opcional
- Lors de l'utilisation du hauban en option

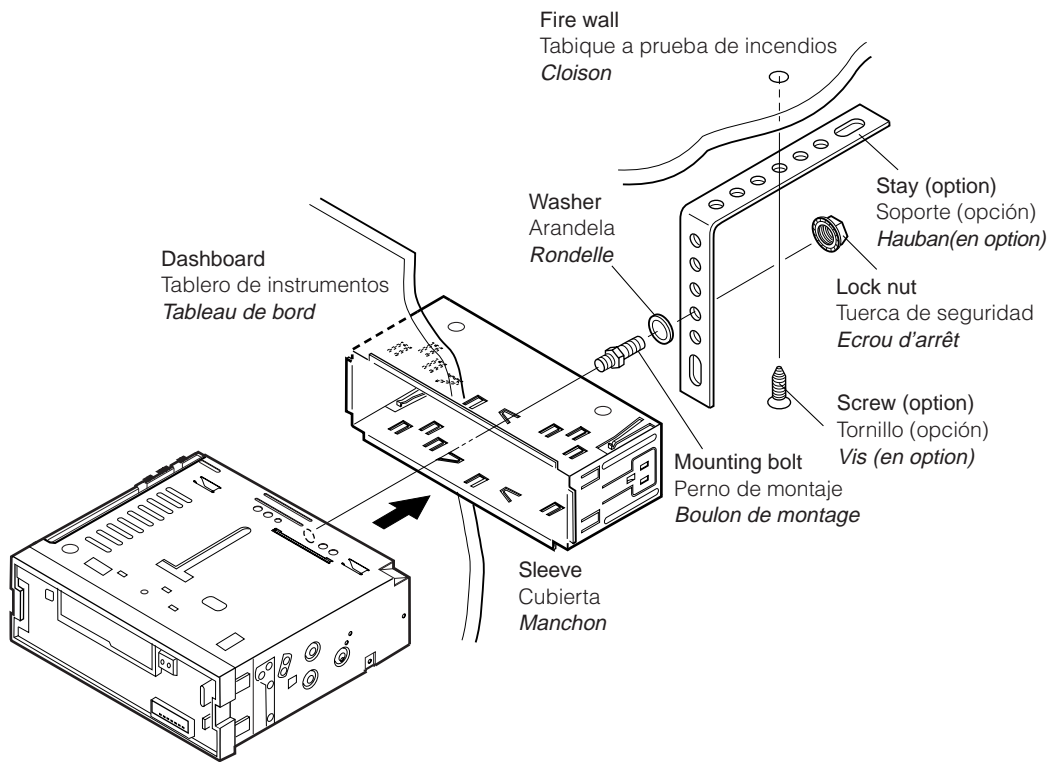

- When installing the unit without using the sleeve
- Instalación de la unidad sin utilizar la cubierta
- Lors de l'installation de l'appareil sans utiliser de manchon

In a Toyota for example, first remove the car radio and install the unit in its place.  
En un Toyota por ejemplo, primero extraiga la radio del automóvil y luego instale la unidad en su lugar.  
Par exemple dans une Toyota, retirer d'abord l'autoradio et installer l'appareil à la place.

Flat type screws (M5 x 6 mm)\*  
Tornillos tipo plano (M5 x 6 mm)\*  
Vis à tête plate (M5 x 6 mm)\*

\* Not included with this unit.  
\* No suministrado con esta unidad.  
\* Non fourni avec cet appareil.

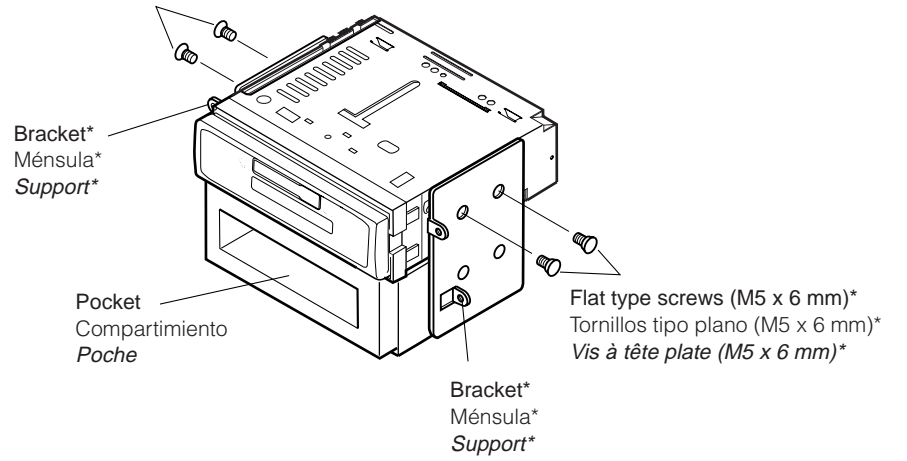

**Note:** When installing the unit on the mounting bracket, make sure to use the 6 mm-long screws. If longer screws are used, they could damage the unit.

**Nota:** Cuando instala la unidad en la ménsula de montaje, asegúrese de utilizar los tornillos de 6 mm de longitud. Si se utilizan tornillos más largos, éstos pueden dañar la unidad.

**Remarque:** Lors de l'installation de l'appareil sur le support de montage, s'assurer d'utiliser des vis d'une longueur de 6 mm. Si des vis plus longues sont utilisées, elles peuvent endommager l'appareil.

### Removing the unit

- Before removing the unit, release the rear section.

- 1 Remove the control panel.
- 2 Remove the trim plate.
- 3 Insert the 2 handles into the slots, as shown. Then, while gently pulling the handles away from each other, slide out the unit. (Be sure to keep the handles after installing it.)

### Extracción de la unidad

- Antes de extraer la unidad, libere la sección trasera.

- 1 Extraiga el panel de control.
- 2 Retire la placa de guarnición.
- 3 Inserte las 2 manijas entre las ranuras, como se muestra. Luego, separe gentilmente las manijas y extraiga la unidad. (Asegúrese de conservar las manijas después de instalarlo.)

### Retrait de l'appareil

- Avant de retirer l'appareil, libérer la section arrière.

- 1 Retirer le panneau de commande.
- 2 Retirer la plaque d'assemblage.
- 3 Introduire les deux poignées dans les fentes, comme montré. Puis, tout en tirant doucement les poignées écartées, faire glisser l'appareil pour le sortir. (S'assurer de conserver les poignées après l'installation de l'appareil.)

1

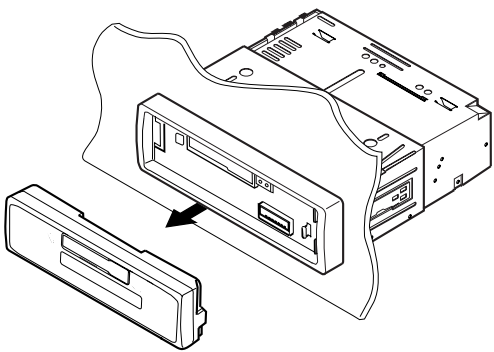

2

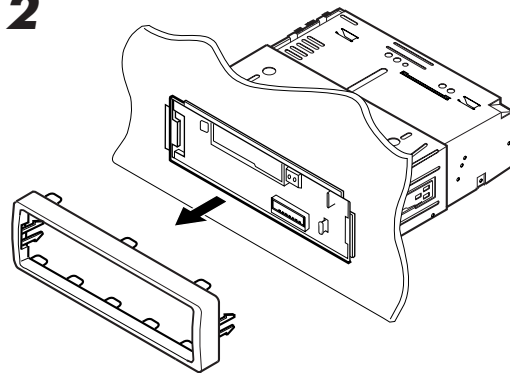

3

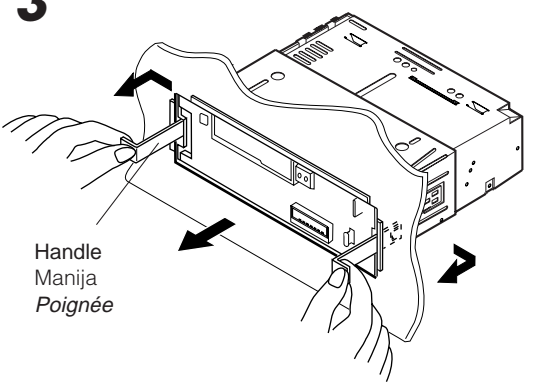

### Parts list for installation and connection

The following parts are provided with this unit.  
After checking them, please set them correctly.

Hard case  
Estuche duro  
Etui de transport

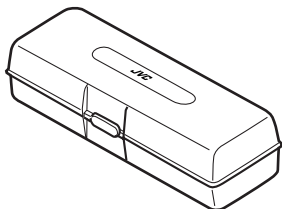

Trim plate  
Placa de guarnición  
Plaque d'assemblage

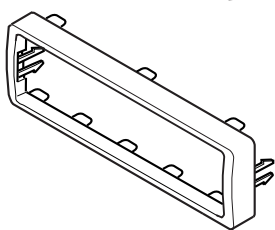

Sleeve  
Cubierta  
Manchon

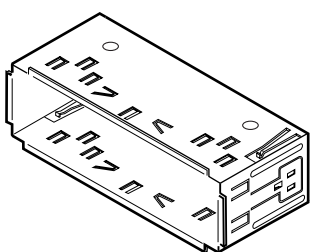

### Lista de piezas para instalación y conexión

Con esta unidad se suministran las siguientes piezas.  
Después de inspeccionarlas, colóquelas correctamente.

Power cord  
Cordón de alimentación  
Cordon d'alimentation

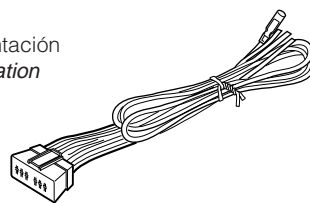

Handles  
Manijas  
Poignées



Rubber cushion  
Cojín de goma  
Amortisseur en caoutchouc



### Liste des pièces pour l'installation et raccordement

Les pièces suivantes sont fournies avec cet appareil.  
Après vérification, veuillez les placer correctement.

Lock nut (M5)  
Tuerca de seguridad (M5)  
Ecrou d'arrêt (M5)



Mounting bolt (M5 x 20 mm)  
Perno de montaje (M5 x 20 mm)  
Boulon de montage (M5 x 20 mm)



Washer (ø5)  
Arandela (ø5)  
Rondelle (ø5)



# ELECTRICAL CONNECTIONS

To prevent short circuits, we recommend that you disconnect the battery's negative terminal and make all electrical connections before installing the unit. If you are not sure how to install this unit correctly, have it installed by a qualified technician.

**Note:**

This unit is designed to operate on **12 volts DC, NEGATIVE ground electrical systems**. If your vehicle does not have this system, a voltage inverter is required, which can be purchased at JVC car audio dealers.

- Replace the fuse with one of the specified rating. If the fuse blows frequently, consult your JVC car audio dealer.
- If noise is a problem... This unit incorporates a noise filter in the power circuit. However, with some vehicles, clicking or other unwanted noise may occur. If this happens, connect the unit's **rear ground terminal** (See connection diagram below.) to the car's chassis using shorter and thicker cords, such as copper braiding or gauge wire. If noise still persists, consult your JVC car audio dealer.
- Maximum input of the speakers should be more than 40 watts at the rear and 40 watts at the front, with an impedance of **4 to 8 ohms**.
- **Be sure to ground this unit to the car's chassis.**
- The heat sink becomes very hot after use. Be careful not to touch it when removing this unit.

Heat sink  
Sumidero térmico  
Dissipateur de chaleur

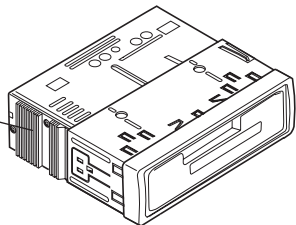

# CONEXIONES ELECTRICAS

Para evitar cortocircuitos, recomendamos que desconecte el terminal negativo de la batería y que efectúe todas las conexiones eléctricas antes de instalar la unidad. Si usted no está seguro de cómo instalar correctamente la unidad, hágala instalar por un técnico cualificado.

**Nota:**

Esta unidad está diseñada para funcionar con **12 voltios de CC, con sistemas eléctricos de masa NEGATIVA**. Si su vehículo no posee este sistema, será necesario un inversor de tensión, que puede ser adquirido en los concesionarios de JVC de equipos de audio para automóviles.

- Reemplace el fusible por uno con la corriente especificada. Si el fusible se quemase frecuentemente consulte con su concesionario de JVC de equipos de audio para automóviles.
- Si el ruido fuese un problema... Esta unidad tiene un filtro de ruido en el circuito de alimentación. Sin embargo, en algunos vehículos, pueden producirse chasquidos u otros ruidos indeseados. En tal caso conecte el **terminal de tierra posterior** (Ver diagrama de conexión abajo.) del receptor al chasis del automóvil, utilizando cordones más gruesos y cortos tales como alambre de cobre trenzado o de grueso calibre. Si el ruido persiste, consulte a su concesionario de JVC de equipos de audio para automóvil.
- La entrada máxima de los altavoces traseros debe ser mayor de 40 vatios y la de los delanteros de 40 vatios, con una impedancia de **4 a 8 ohmios**.
- **Asegúrese de conectar esta unidad a tierra en el chasis del automóvil.**
- El sumidero térmico estará muy caliente después del uso. Asegúrese de no tocarlo al desmontar esta unidad.

# RACCORDEMENTS ELECTRIQUES

Pour éviter tout court-circuit, nous vous recommandons de débrancher la borne négative de la batterie et d'effectuer tous les raccordements électriques avant d'installer l'appareil. Si l'on n'est pas sûr de pouvoir installer correctement cet appareil, le faire installer par un technicien qualifié.

**Remarque:**

Cet appareil est conçu pour fonctionner sur des sources de courant continu de **12 volts à masse NEGATIVE**. Si votre véhicule n'offre pas ce type d'alimentation, il vous faut un convertisseur de tension, que vous pouvez acheter chez un revendeur d'autoradios JVC.

- Remplacer le fusible par un de la valeur précisée. Si le fusible saute souvent, consulter votre revendeur d'autoradios JVC.
- Si le bruit est un problème... Cet appareil incorpore un filtre de bruit dans le circuit d'alimentation. Cependant, avec certains véhicules, quelques claquements ou autres bruits non désirés risquent de se produire. Si cela arrive, raccorder la **borne de masse arrière** de l'appareil au châssis de la voiture (voir le schéma de raccordement ci-dessous) en utilisant des cordons les plus gros et les plus courts possibles telle qu'une barre de cuivre ou une tresse. Si le bruit persiste, consulter votre revendeur d'autoradios JVC.
- La puissance admissible des haut-parleurs doit être supérieure à 40 watts à l'arrière et à 40 watts l'avant, avec une impédance de **4 à 8 ohms**.
- **S'assurer de raccorder la mise à la masse de cet appareil au châssis de la voiture.**
- Le radiateur devient très chaud après usage. Faire attention de ne pas le toucher en retirant cet appareil.

## A Typical Connections / Conexiones típicas / Raccordements typiques

**Before connecting:** Check the wiring in the vehicle carefully not to fail in connecting this unit. Incorrect connection may cause a serious damage to this unit.

- 1 Connect the colored leads of the power cord to the car battery, speakers and automatic antenna (if any) in the following sequence.
  - ① Black: ground
  - ② Yellow: to car battery (constant 12V)
  - ③ Red: to an accessory terminal
  - ④ Blue with white stripe: to automatic antenna (200mA max.)
  - ⑤ Others: to speakers
- 2 Connect the antenna cord.
- 3 Finally connect the wiring harness to the unit.

**Antes de la conexión:** Verifique atentamente el conexionado del vehículo para no cometer errores al conectar esta unidad. Una conexión incorrecta podría producir daños graves en la unidad.

- 1 Conecte los conductores de color del cable de alimentación a la batería del automóvil, altavoces y antena automática (si la hubiere) en la secuencia siguiente.
  - ① Negro: a tierra.
  - ② Amarillo: a la batería del automóvil (12V constantes)
  - ③ Rojo: a un terminal de accesorio
  - ④ Azul con rayas blancas: a la antena automática (200mA máx.)
  - ⑤ Otros: a los altavoces
- 2 Conecte el cable de antena.
- 3 Por último, conecte a la unidad el cableado preformado.

**Avant de commencer la connexion:** vérifiez attentivement le câblage du véhicule pour ne pas connecter incorrectement cet appareil. Une connexion incorrecte peut endommager sérieusement l'appareil.

- 1 Connectez les fils de couleur du cordon d'alimentation à la batterie de la voiture, aux enceintes et à l'antenne automatique (s'il y en a une) dans l'ordre suivant.
  - ① Noir: a la masse
  - ② Jaune: a la batterie de la voiture (12V constant)
  - ③ Rouge: à la prise accessoire
  - ④ Bleu à bandes blanches: à l'antenne automatique (200mA max.)
  - ⑤ Autres: aux enceintes
- 2 Connectez le cordon d'antenne.
- 3 Finalement, connectez le faisceau de fils à l'appareil.

**\* Before connecting the CD changer, make sure that the unit is turned off.**  
**\* Antes de conectar el cambiador de CD, asegúrese de que la unidad esté apagada.**  
**\* Avant de connecter le changeur CD, s'assurer que l'unité est éteinte.**

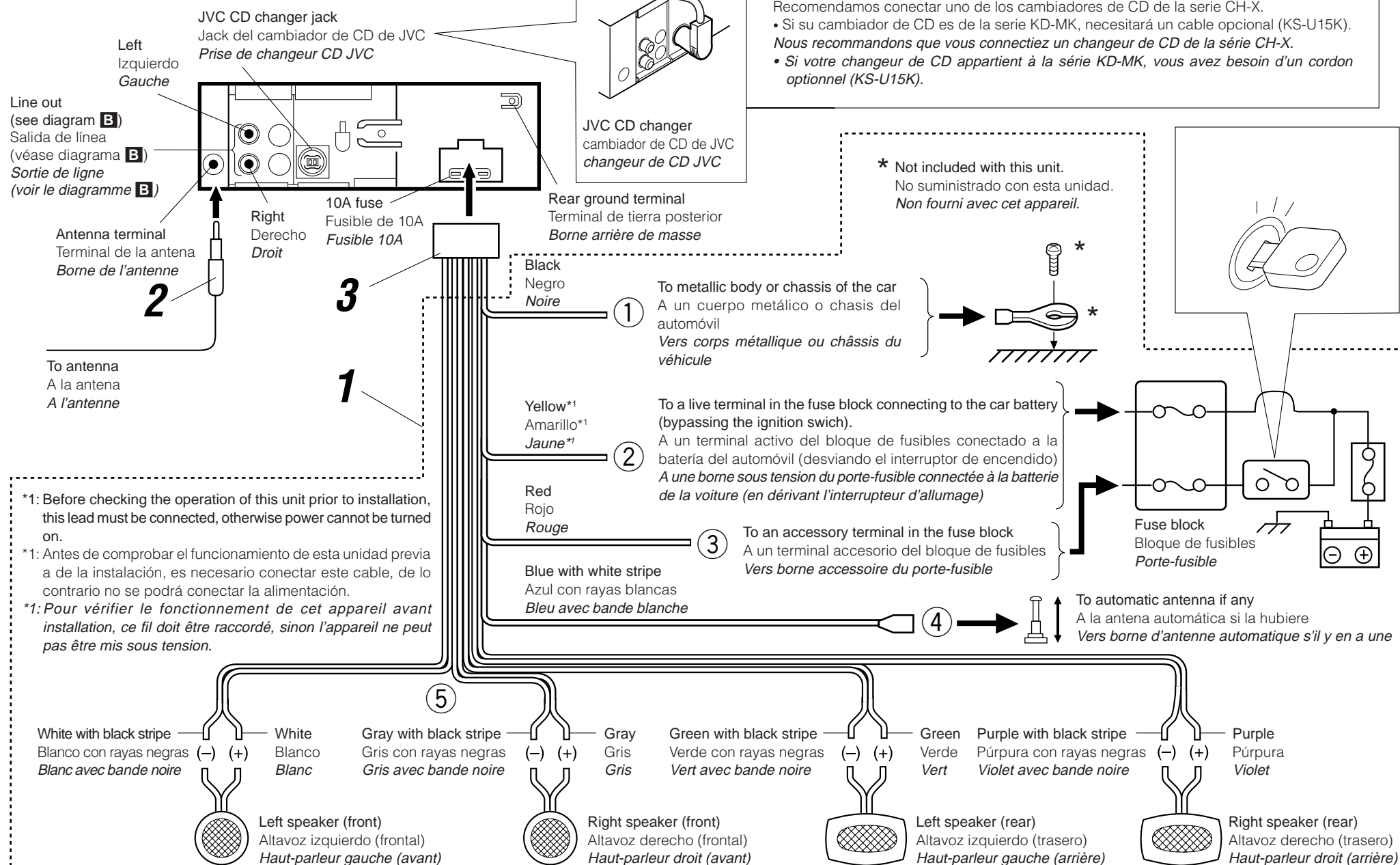

\*1: Before checking the operation of this unit prior to installation, this lead must be connected, otherwise power cannot be turned on.  
 \*1: Antes de comprobar el funcionamiento de esta unidad previa a de la instalación, es necesario conectar este cable, de lo contrario no se podrá conectar la alimentación.  
 \*1: Pour vérifier le fonctionnement de cet appareil avant installation, ce fil doit être raccordé, sinon l'appareil ne peut pas être mis sous tension.



### PRECAUTIONS on power supply and speaker connections:

- **DO NOT** connect the speaker leads of the power cord to the car battery; otherwise, the unit will be seriously damaged.
- Connect the black lead (ground), yellow lead (to car battery, constant 12V), and red lead (to an accessory terminal) correctly.
- **BEFORE** connecting the speaker leads of the power cord to the speakers, check the speaker wiring in your car.
  - If the speaker wiring in your car is as illustrated in Fig. 1 and Fig. 2 below, **DO NOT** connect the unit using that original speaker wiring. If you do, the unit will be seriously damaged. Redo the speaker wiring so that you can connect the unit to the speakers as illustrated in Fig. 3.
  - If the speaker wiring in your car is as illustrated in Fig. 3, you can connect the unit using the original speaker wiring in your car.
  - If you are not sure of the speaker wiring of your car, consult your car dealer.

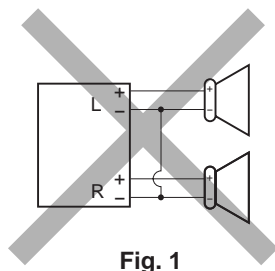

Fig. 1

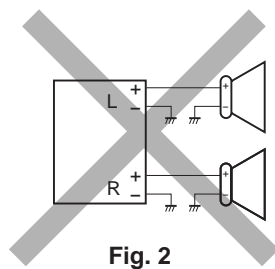

Fig. 2

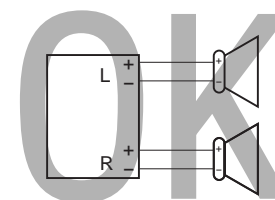

Fig. 3

### PRECAUCIONES sobre las conexiones de la fuente de alimentación y de los altavoces:

- **NO** conecte los conductores de altavoz del cable de alimentación a la batería de automóvil, pues podrían producirse graves daños en la unidad.
- Conecte correctamente el conductor negro (a tierra), el conductor amarillo (a la batería del automóvil, 12V constantes), y el conductor rojo (a un terminal de accesorio).
- **ANTES** de conectar a los altavoces los conductores de altavoz del cable de alimentación, verifique el conexionado de altavoz de su automóvil.
  - Si el conexionado de altavoz de su automóvil es como se indica en las Figs. 1 y 2 de abajo, **NO** conecte la unidad utilizando ese conexionado de altavoz original. Si lo hace, se producirán daños graves en la unidad. Vuelva a efectuar el conexionado de altavoz de manera que pueda conectar la unidad a los altavoces de la manera indicada en la Fig.3.
  - Si el conexionado de altavoz de su automóvil es como se indica en la Fig.3, podrá conectar la unidad utilizando el conexionado de altavoz original de su automóvil.
  - Si tiene dudas sobre el conexionado de altavoz de su automóvil, consulte con su concesionario.

### PRECAUTIONS sur l'alimentation et la connexion des enceintes:

- **NE CONNECTEZ PAS** les fils d'enceintes du cordon d'alimentation à la batterie; sinon, l'appareil serait sérieusement endommagé.
- Connectez correctement le fil noir (à la masse), le fil jaune (à la batterie de la voiture, 12V constant) et le fil rouge (à la prise accessoire).
- **AVANT** de connecter les fils d'enceintes du cordon d'alimentation aux enceintes, vérifiez le câblage des enceintes de votre voiture.
  - Si le câblage des enceintes de votre voiture est réalisé comme montré sur la Fig. 1 ou Fig. 2 ci-dessous, **NE CONNECTEZ PAS** l'appareil en utilisant ce câblage original d'enceintes. Si vous le faites, l'appareil sera sérieusement endommagé. Recommencez le câblage des enceintes de façon que vous puissiez connecter l'appareil aux enceintes comme montré sur la Fig. 3.
  - Si le câblage des enceintes de votre voiture est comme montré sur la Fig. 3, vous pouvez connecter l'appareil en utilisant ce câblage original d'enceintes pour votre voiture.
  - Si vous n'êtes pas sûrs du câblage d'enceintes de votre voiture, consultez le concessionnaire de votre voiture.

### Connecting the leads / Conexión de los conductores / Raccordement des fils

Twist the core wires when connecting. Retuerza los alambres de alma para conectarlos.  
Torsader les âmes des fils en les raccordant.

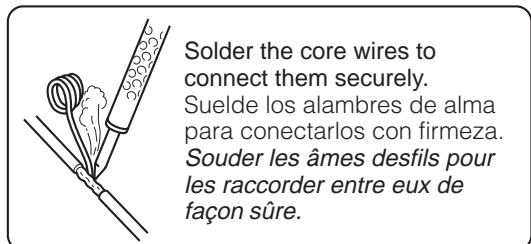

#### CAUTION / PRECAUCION / PRECAUTION:

- To prevent short-circuit, cover the terminals of the **UNUSED** leads with insulating tape.
- Para evitar cortocircuitos, cubra los cables **NO UTILIZADOS** con cinta aislante.
- Pour éviter les court-circuits, couvrir les bornes des fils qui ne sont **PAS** utilisés avec de la bande isolante

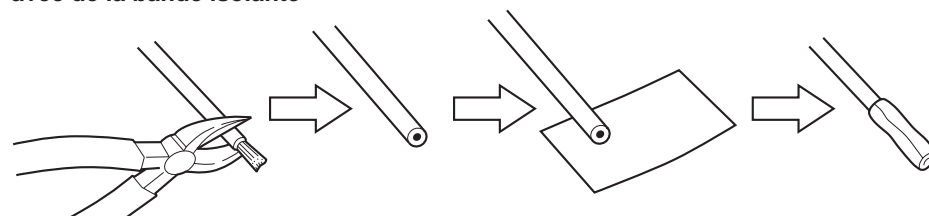

### B Connections Adding Other Equipment / Conexiones para añadir otros equipos / Raccordement pour ajouter d'autres appareils

Since this unit has line-out terminals, an amplifier and other equipment can be used to upgrade your car stereo system.

- Connect the remote lead (blue with white stripe) to the remote lead of the other equipment so that it can be supplied the power through this unit.
- For amplifier only: Connect this unit's line-out terminals to the amplifier's line-in terminals.

Como esta unidad posee terminales de salida de línea, se puede utilizar un amplificador u otro equipamiento para mejorar el sistema estereofónico de su automóvil.

- Conecte el cable remoto (azul con rayas blancas) al cable remoto del otro equipo para que pueda suministrarse energía a través de esta unidad.
- Sólo para el amplificador: Con un amplificador, conecte los terminales de salida de línea de esta unidad con los terminales de entrada de línea del amplificador.

Comme cet appareil a des bornes de sortie de ligne, un amplificateur et d'autres appareils peuvent être utilisés pour améliorer votre chaîne stéréo automobile.

- Connecter le fil d'alimentation à distance (bleu avec des bandes blanches) au fil d'alimentation à distance de l'autre appareil de façon qu'il puisse être alimenté par cet appareil.
- Pour l'amplificateur seulement: Raccorder les bornes de sortie ligne de cet appareil aux bornes d'entrée ligne de l'amplificateur.

### Amplifier / Amplificador / Amplificateur

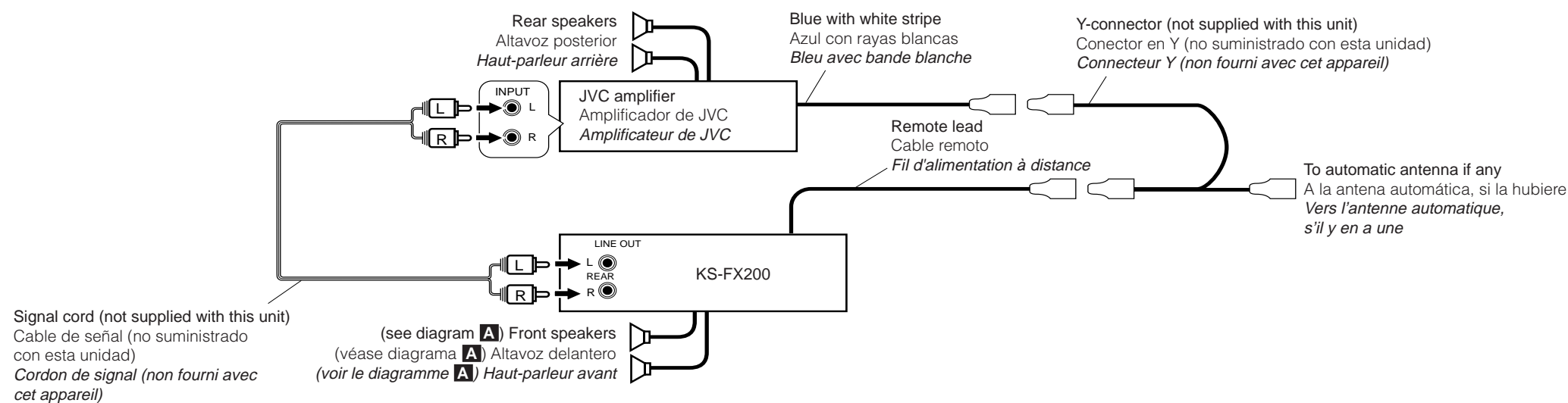

### TROUBLESHOOTING

- **The fuse blows.**
  - \* Are the red and black leads connected correctly?
- **Power cannot be turned on.**
  - \* Is the yellow lead connected?
- **No sound from the speakers.**
  - \* Is the speaker output lead short-circuited?
- **Sound is distorted.**
  - \* Is the speaker output lead grounded?
  - \* Are the "-" terminals of L and R speakers grounded in common?
- **Unit becomes hot.**
  - \* Is the speaker output lead grounded?
  - \* Are the "-" terminals of L and R speakers grounded in common?

### LOCALIZACION DE AVERIAS

- **El fusible se quema.**
  - \* ¿Están los conductores rojo y negro correctamente conectados?
- **No es posible conectar la alimentación.**
  - \* ¿Está el cable amarillo conectado?
- **No sale sonido de los altavoces.**
  - \* ¿Está el cable de salida del altavoz cortocircuitado?
- **El sonido presenta distorsión.**
  - \* ¿Está el cable de salida del altavoz conectado a masa?
  - \* ¿Están los terminales "-" de los altavoces L y R conectados a una masa común?
- **La unidad se calienta.**
  - \* ¿Está el cable de salida del altavoz conectado a masa?
  - \* ¿Están los terminales "-" de los altavoces L y R conectados a una masa común?

### EN CAS DE DIFFICULTÉS

- **Le fusible saute.**
  - \* Les fils rouge et noir sont-ils raccordés correctement?
- **L'appareil ne peut pas être mise sous tension.**
  - \* Le fil jaune est-elle raccordée?
- **Pas de son des haut-parleurs.**
  - \* Le fil de sortie de haut-parleur est-il court-circuité?
- **Le son est déformé.**
  - \* Le fil de sortie de haut-parleur est-il à la masse?
  - \* Les bornes "-" des haut-parleurs gauche et droit sont-elles mises ensemble à la masse?
- **L'appareil devient chaud.**
  - \* Le fil de sortie de haut-parleur est-il à la masse?
  - \* Les bornes "-" des haut-parleurs gauche et droit sont-elles mises ensemble à la masse?